

XL

LARGE CAPACITY FLYING OPTIC LASER

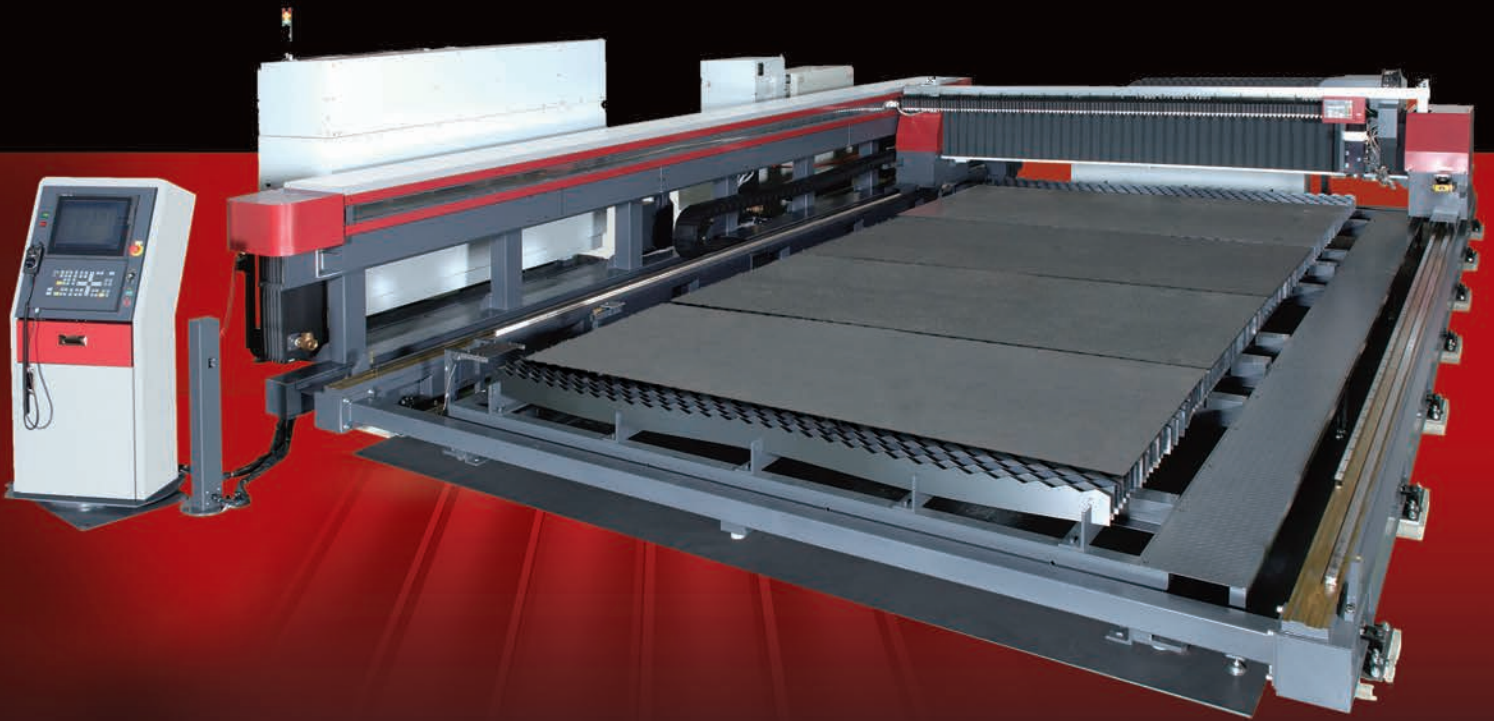

6030XL

Precise Large Work Area

In laser processing, the bottom line is simultaneously ensuring high productivity and performance. Mitsubishi Laser 6030XL achieves this through its large scale processing capabilities, while maintaining performance comparable to that of general purpose, high speed laser processing machines. Its flying optic design provides diverse applications at high speed, with precision, the 6030XL is the comprehensive solution.



Machines now come with standard safety covers.

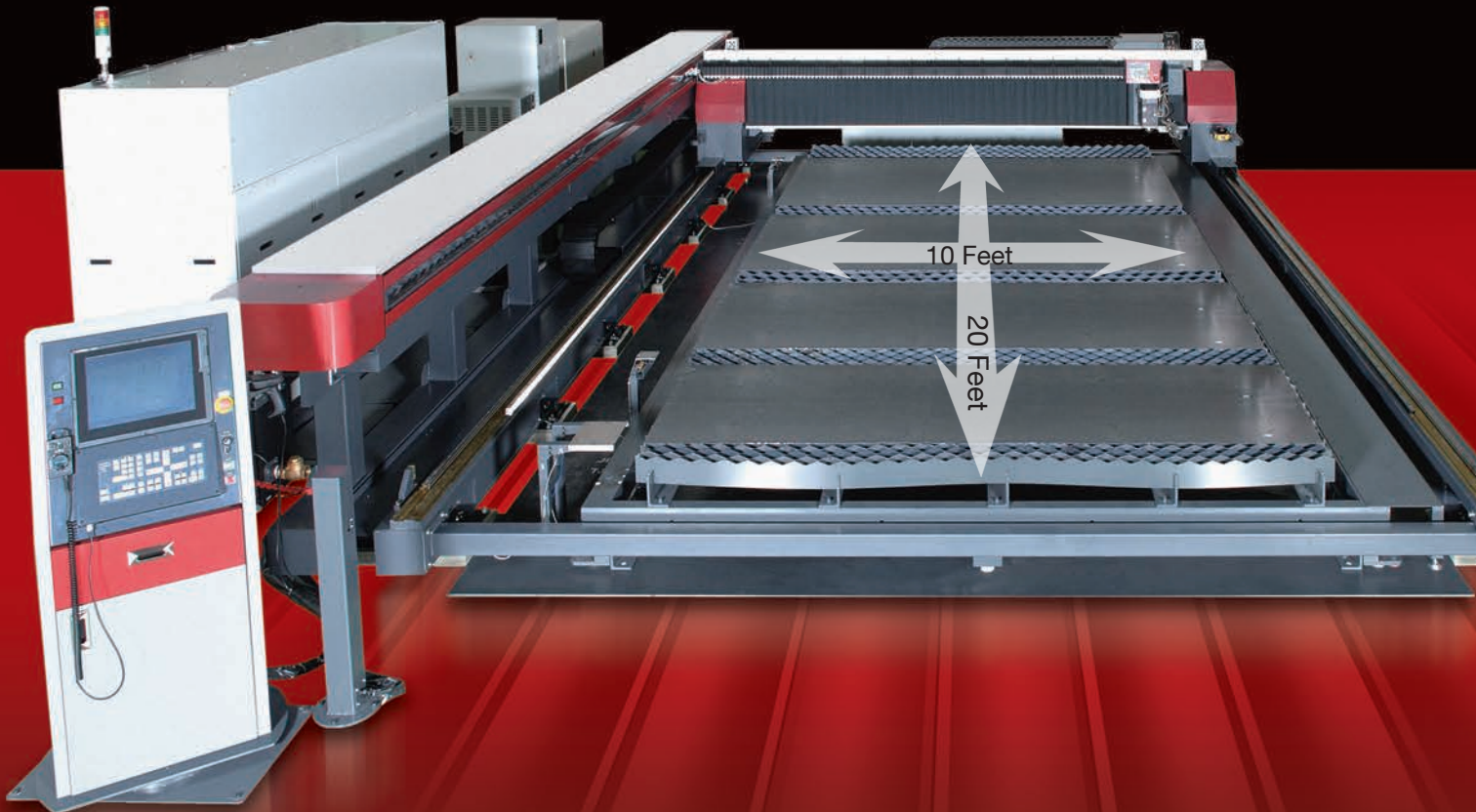

Unique Features of the XL Machine

- Diversify your cutting capacities with large table
- Increase your shop flexibility
- Improve Material Utilization
- Cutting capability from thick to thin
- Can accommodate a wide variety of sheet sizes, from 4x4, to 5x10, to 6x12 to 8x20 or 10x20
- Acceleration and Deceleration speeds are exceptional due to the flying optic design, increasing your cutting efficiency
- Overall processing time is superior to traditional large format laser machines
- XL design is based on our popular 5x10 eX model, our biggest selling machine in our line up
- Automation Ready – Simple load unload to full blown automation with product carts and shuttles are available.

HEAD & MOTION SYSTEM

MITSUBISHI'S PATENTED DIAMOND PATH TECHNOLOGY

- Maintains a constant beam quality by fixing the system's beam path length regardless of processing head location
- Achieves superior cut edge quality and processing consistency over the entire work area
- Provides a stable cutting beam at high speeds across all processing areas at speeds of up to 1,970 in/min (50 m/min)
- Ensures consistent corner-to-corner cutting on any application
- Integrated Beam Optimizer automatically adjusts the beam characteristics for maximum processing speed and efficiency
- Lens failure detection feature (good for automation) comes standard on 45CF-R

Diamond Path Advanced Beam Delivery System

Highly stable processing at every point in the processing area

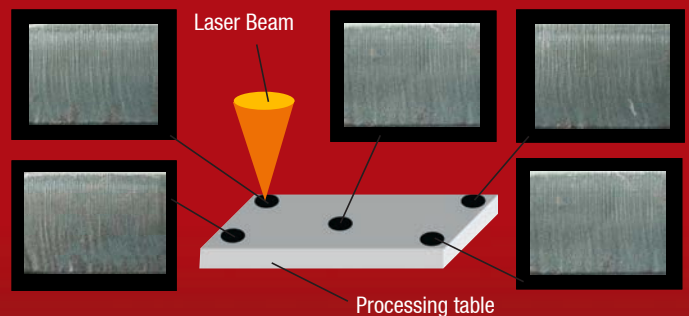

MITSUBISHI 700 SERIES CONTROL

TAKE CONTROL OF YOUR CUTTING

Competing manufacturers' PC-based controls can't touch the sophistication of the new Mitsubishi 700 Series CNC controls. Mitsubishi has utilized its vast experience developing the most sophisticated and accurate controls for laser machines and implemented new nanotechnology for finer, faster interpolation with greater power. Our CNC controls include a 15-inch touch screen, 64-bit Windows XP, ethernet for input/output and a USB port for further flexibility.

700 SERIES CNC ALSO FEATURES:

- Dedicated nano-control for highest precision machining
- Newest RISC-CPU and high-performance ASIC
- Improved and accelerated graphics with superior NC design simplify operations
- Network function adaptable for diverse factory environments
- USB Compatible
- Sheet detection
- LAN-Ethernet connectivity
- Decreased graphic time
- Increased cutting condition database
- Improved help diagnostic functions
- Micro-joint function
- 20 GB Hard Drive
- 2 Action Cutting provides automatic setup and easy operator interface
 - Step 1 - use barcode reader and automatically load onto NC from CAD/CAM computer
 - Step 2 - once data loaded, head moves to start positions, automatically measures the tilt, the size and the edge of the workpiece, and starts cutting
- New Reset - Restart Function
- Simple Nesting - rectangular nesting of dissimilar parts at control
- Advanced help and maintenance screens are a great aid for operators
- Arc Evade



Handle Box and Bar Code Reader combine for a more user friendly experience.

IMPROVED CUTTING CONDITION DATA

Cutting condition library memory is increased. The controller will now hold 1000 libraries of 17 conditions.

The libraries have become more intelligent. Nozzle diameter and lens focal length parameters are now data fields in the condition pages. This allows for new functions like Automatic Height Sensor calibration.



Automatic Height Sensor calibration calibrates height sensor whenever the nozzle is changed. This function will give more consistent processing capability.

MAINTENANCE GUIDE

Our new maintenance screens provide step by step instructions for most resonator maintenance functions. All of these steps are built into the control for ease of use and convenience for your operator.

Safety is our main concern at Mitsubishi, our machine is built to allow our users to perform their own maintenance on certain components of the machine. This is why we have built special JIGS to make it easier and safer for our customers to keep their machines up and running at peak efficiency.

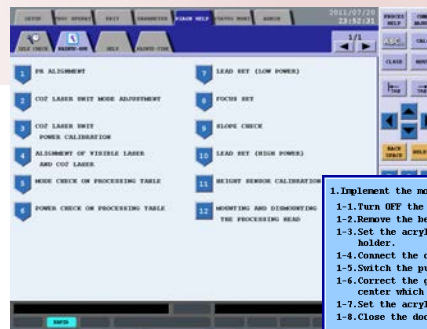

1. Implement the mode adjustment at the outlet of the CO2 laser unit.
 1-1. Turn OFF the "LASER READY" key.
 1-2. Remove the beam passage duct.
 1-3. Set the acrylic plate of about 15mm thickness to the acrylic plate holder.
 1-4. Connect the coupler of the acrylic plate holder to the column.
 1-5. Switch the purge gas change valve to the "measurement box" side.
 1-6. Correct the gas which has come out of the flexible hose at the center which burns the mode.
 1-7. Set the acrylic plate holder to the measurement box.
 1-8. Close the door of the measurement box.

1-9. Turn ON the "LASER READY" key.
 1-10. Press the following button.
***) Turn to yellow.**
MODE ADJUST
 1-11. Press the "START" switch.
***) The beam will irradiate for about 1.5 seconds.**
 1-12. After the program is completed, turn OFF the "LASER READY" key.
 1-13. Check the pattern on the acrylic.
 When the adjustment of the mode is necessary, adjust the micrometer of the PR and TR side.
 Refer to "CO2 laser unit manual" for the adjustment method.
 After adjustment, displace the acrylic plate.
 And implement from the above "1-9" to "1-13".
 If the adjustment of the mode is not needed, then to "1-11".

1-14. Turn OFF the "LASER READY" key.
 1-15. Clean the CO2 laser unit M2 mirror.
 After the cleaning, correct the visible beam to the position before the cleaning is done.
 1-16. When the CO2 laser unit power calibration is done, implement following work. If not, proceed to "1-17".
 Switch the purge gas change valve to the "close" side.
 Remove the column from the coupler of the acrylic plate holder.
 Remove the acrylic plate holder from measurement box.
 Touch following "TO POWER CALIB" button.
 1-17. When the power calibration is not done, implement following work.
 Switch the purge gas change valve to the "close" side.
 Remove the column from the coupler of the acrylic plate holder.
 Remove the acrylic plate holder from measurement box.
 Switch the purge gas change valve to the "at processing" side.
 Install the beam passage duct.
 Close the door of the measurement box.
 It's end by the above work.
***) When you continuously burn the mode, wait for about 7 minutes to burn the mode.**
TO POWER CALIB
CLOSE

RESONATORS

Lowest cost of ownership

Mitsubishi resonators are so reliable and efficient that they've never needed to be replaced – eliminating a potentially expensive repair. The innovative Cross-Flow design consumes up to 90% less gas than traditional fast-flow systems, giving our resonators the lowest cost of ownership on the market.

MITSUBISHI'S EXCLUSIVE X-FLOW R SERIES RESONATOR

- Revolutionary "Dual" Cross-Flow design maximizes beam quality and stability
- DiamondClean™ Technology provides ultra-clean resonator materials that yield higher performance and greater stability
- Lower gas costs – consumes up to 90% less gas than traditional fast-flow systems
- Extended maintenance intervals equal less maintenance
- Improved power supply provides high efficiency, stability, reliability and lower maintenance
- Fast startup
- Designed and manufactured exclusively by Mitsubishi
- Available w/4.5kW
- Enhanced rectangular wave pulse
- No chemical additives for chiller

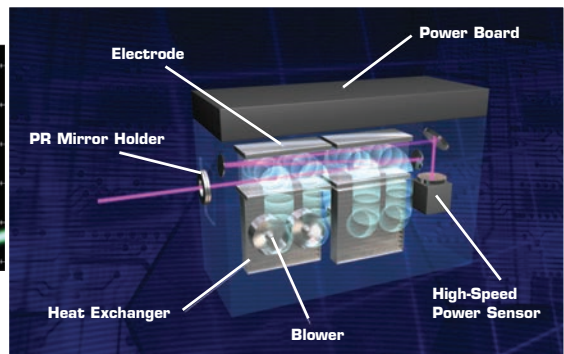
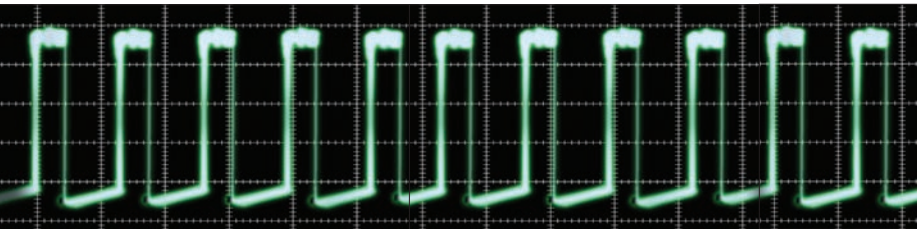

MITSUBISHI'S SUPERIOR "CUTTING POWER"

Output power alone does not define cutting performance or cut edge quality. It takes superior "cutting power" to achieve high-performance results. Cutting power is optimized by creating the perfect blend of output power, beam quality, beam stability and power control. The results are visible through superior edge quality, lower thermal effects, precision cutting ability and greater overall processing control.

BRILLIANT NEW TECHNOLOGY

Mitsubishi's new state-of-the-art BrilliantCUT technology can produce a cutting surface near-machined finish – eliminating secondary operations and decreasing production times. The XL Series reaps the benefits of this innovative, optimal machine tool beam path design. The new CF-R resonator has increased beam characteristics and a new control method for the high-peak rectangular-pulse platform, providing optimal processing conditions for the resonator. It also features new nozzle technology for improved cutting surface quality.

BrilliantCUT is ideal for stainless steel applications 3/8" (9.5 mm) and up. With an increased focus margin, processing stability is increased for a more consistent cut. BrilliantCUT also provides better part straightness by controlling the Kerf on the bottom of the part. And, the ability to control the heat affected zone of the material (bottom of part) eliminates the need for secondary processes. Simply brilliant.

*Data to the right is for reference. Surface discoloration may differ depending on material, thickness, processing condition or state of the processing machine.

Conventional Cut Surface



Brilliant Cut Surface

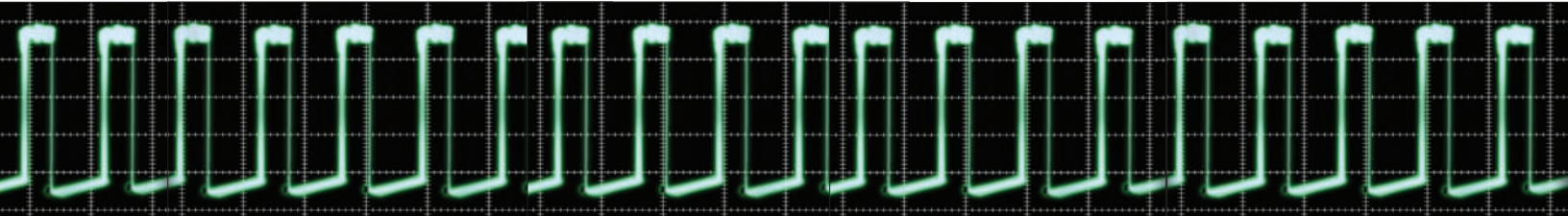
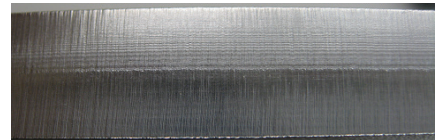

PLASMA GUARD CONTROL

Conventional lasers exhibit a crude transition as speed increases from starting point to corner. Plasma Guard Control restricts the generation of plasma in mid-thick stainless steel, allowing for a much smoother acceleration. Increased corner speeds maintain superior cutting quality and stability for maximum precision production.

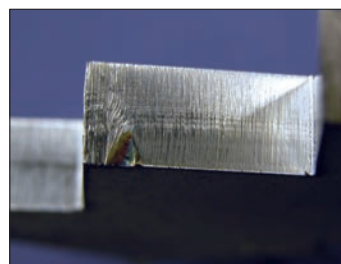

Plasma Guard Control off

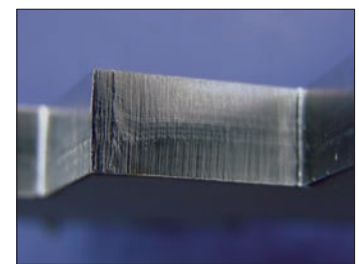

Plasma Guard Control on

- Plasma Guard (PG) Control smoothly steps up acceleration on the pierce line and corner sections.
- PG control restricts the generation of plasma in Stainless Steel Plate which improves cutting quality, cutting stability and ease of use.

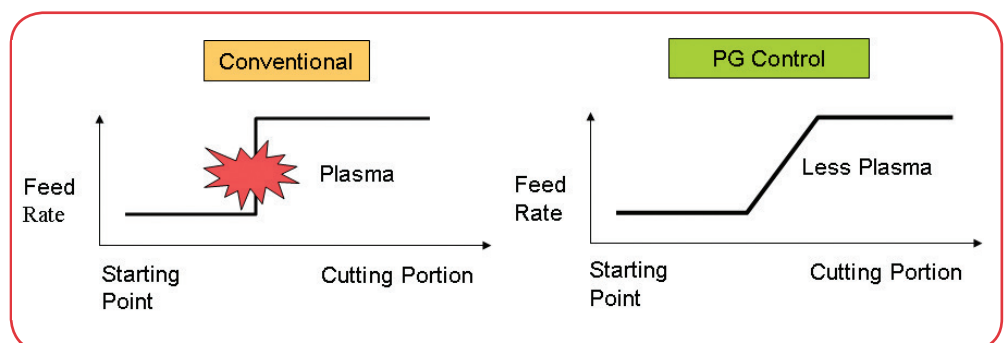

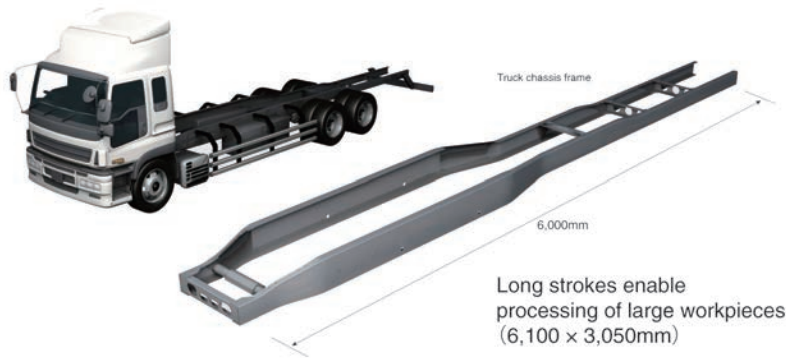

GET XL PRODUCTIVITY AND PERFORMANCE

Our Large size laser processing machine makes it possible to cut out chassis frames as one piece rather than several pieces. The benefit to you is the elimination of bending and fabrication processes and an increase to the bottom line.

Further more the ability to cut single, large work pieces eliminates welding processes that were previously necessary to join small parts.



GET XL APPLICATIONS

When Conventional size Laser Systems don't fit your application. The XL from Mitsubishi is the answer for problem free cutting of oversized, specialized processing. The XL addresses a variety of markets including;

- Subway Car Construction
- Bridges and steel construction
- Steel Service center
- Shipbuilding
- Manufacturing of farm and construction vehicles
- Building Machines
- Large Agriculture equipment
- Large crane booms
- Large Truck Suspension



AUTOMATED CONFIGURATIONS

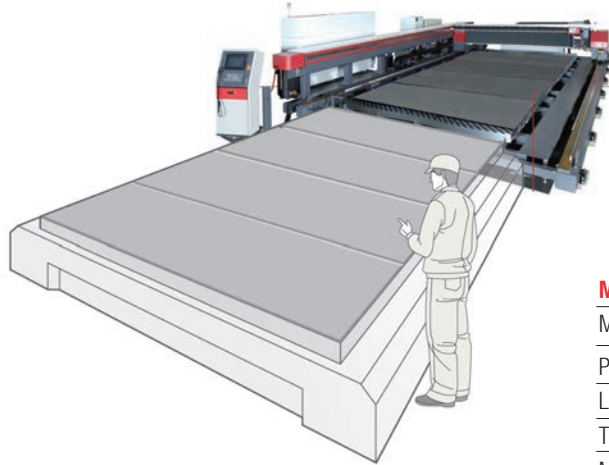

Pallet Changer

- Attaching the pallet changer improves productivity and efficiency to the maximum
- Eight standard-size sheets can be set
- Extra space to set sheets

MSCIII Multiple Sheet Changer

Material size	10'2" x 20' x 1.0" (3100 x 6100 x 25mm)
Pallet size	10'11" x 21'1" x 11" (3340 x 6414 x 279mm)
Laser pass line	2'11" (879mm)
Thickness	.03"~1.0" (0.8~25mm)
Material weight	8800lb (4000kg)
Cycle time	90 seconds

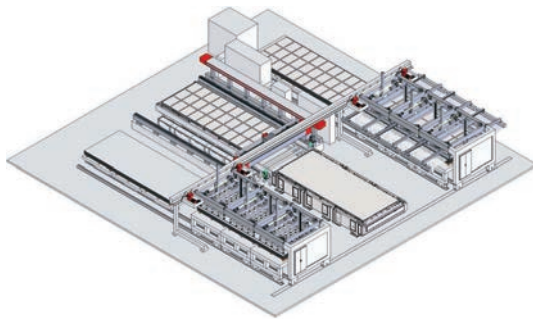

TANDEM LOAD/UNLOAD SYSTEM

- Full load/unload cycle in approximately 95 seconds
- Heavy duty with up to 1 inch full sheet load/unload capacity
- Second material pickup loading station allows simultaneous preparation
- 4 motorized carts 2 load, 2 unload working simultaneously to increase throughput
- 22,000 lb per cart capacity
- XL machine can accept raw material in 4x4, 4x8, 4x10, 5x10, 6x12, and 8x20

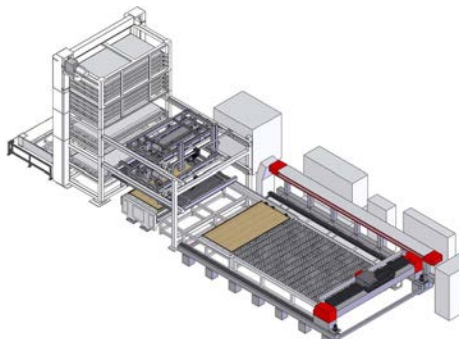

MSCIII Multiple Sheet Changer

Material size	Max 5'x10' (1525 x 3050mm)
Pallet size	5'9" x 11' x 9.4" (1750 x 3350 x 240mm)
Laser pass line	2' 11" (880mm)
Thickness	.03"~1.0"(0.8~25mm)
Material weight	Automation 2030lb (920kg)
Cycle time	Pallet changer 40sec, Prepare next sheet 100sec
Tower	6000lbs/pallet, 90mm load height (w/o skid)

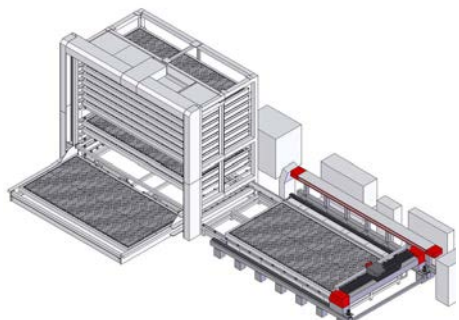

MPS Multiple Sheet Changer/Workpiece per shelf

Material size	10' x 20' (Max. 3,050mm x 6,100mm)
Cutting Pallet size	10'11" x 21' x 9" (3,350mm x 6,400mm x 230mm)
Material pass line	2'7" (800mm)
Tower shelves	6 shelves~12 shelves Height 10 shelves 19'(5800mm)
Material thickness	.03"~1.0"(.08~25mm)
Material weight	8050lb=10' x 20'x 1.0" Max.(3650kg=3050 x 6100 x 25mm)
Cycle time	300sec (pallet change from Tower)

MC MACHINERY SYSTEMS, INC.



THE MITSUBISHI EXPERIENCE

THE FOCUS OF OUR BUSINESS IS THE FUTURE OF YOURS

Everyday we help North American manufacturers adapt and thrive in the ever-changing global manufacturing market. The Mitsubishi Experience is the ingenuity, innovation and support we provide to help you lead the competition on all levels. Our mission is to maximize your potential by delivering unparalleled products, technical expertise, service and support.

MC Machinery Systems, Inc. is part of the global Mitsubishi Corporation. Mitsubishi Corporation employs over 600,000 people around the world across a wide spectrum of industries including machine tools and controls, automotive, aerospace, industrial machinery, elevator, energy, metals, chemicals, food and textiles. Our customers benefit greatly from the knowledge and expertise that flows throughout Mitsubishi, as well as from the overall strength and stability of the corporation. Experience in developing new technologies and solutions for one division benefits customers in all the others.

This effectively broadens the extensive manufacturing and metalworking knowledge of MC Machinery Systems, Inc. to include expertise in virtually every area of manufacturing and allow us to develop the most innovative and effective solutions for your applications.



MAC FUNDING CORPORATION

Get The Financial Backing To Invest In The Future

Bank financing can deplete your available line of credit. With our captive financing arm, MAC Funding, you are financed and backed directly by Mitsubishi with some of the most competitive rates and packages in the equipment finance industry. We offer flexible financing packages structured to accommodate your business needs.

- One-stop financing
- Low interest rates
- Flexible payment schedule

a subsidiary of  Mitsubishi Corporation
MAC FUNDING CORPORATION

The Industry's Most Responsive Service And Support

With more than 100 employees, our regionalized Service Network is the most advanced and responsive team in the industry. We're here for you with phone support, operation training, on-site service, parts inventory and a robust, interactive website. With 20 locations throughout North America, and more scheduled to open, we can respond promptly to your service needs. For the best on-site customer service capabilities, we have more than 25 vans in the field – three times more than any other company in the industry.

From installation and on-site training to support and service throughout the life of your system, our national service network is just a phone call away. No other company has a greater depth of experience and resources than Mitsubishi and MC Machinery Systems. Access 24/7 support with our interactive website, a detailed interactive parts catalog, printable machine manuals and software.

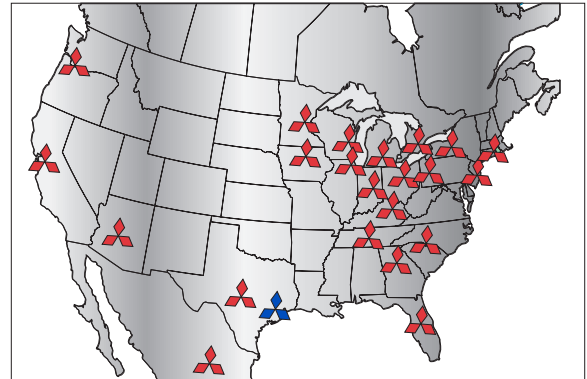

At MC Machinery Systems our number 1 goal is customer satisfaction. We have invested greatly in our infrastructure to better serve our customer base with a state of the art call center, regional service and support and millions of dollars of parts inventory. Now we are excited to introduce the next generation of service tools from MC Machinery systems. Inc. MC Remote 360. This is a robust production monitoring and support solution geared to provide transparency to your laser cutting process. MC Remote 360 provides real-time data to help increase productivity, improve efficiency, and reduce down time for your MC Remote 360 enabled machine.

MC Remote 360 provides

- End User machine monitoring through web enabled device
- MMS Remote Diagnostics & Fault Monitoring Service
- MMS Remote Support Service



Your MC Remote 360 machine can be monitored from many different devices

- Java based PC dashboard
- Mobile Android devices (V2.3+)
- Mobile Apple devices (iOS V4+)
- Apple Tablets (iOS V4+)
- Android tablets (V2.3+)

As long as a live internet connection is accessible, the machines can be monitored from virtually anywhere.

Processing Machine Specifications

Model Name		6030XL	6030XL with Pallet	
Specifications and Performance	Machine structure	X/Y - Precision Rack & Pinion - Z=Precision Ball Screw		
	Travel drive method	X-Y-Z simultaneous 3 axes (Z axis height control is also possible)		
	Max. workpiece size (inch)	240.2 x 120.1 (6100mm x 3050mm)	240.2 x 122 (6100mm x 3100mm)	
	Table pass height	19.7 (500mm)	34.6 (879mm)	
	Pallet changer	NA	Provided	
	Stroke	X-axis stroke (inch)	259.8" (6600mm)	
		Y-axis stroke (inch)	125.98" (3200mm)	
		Z-axis stroke (inch)	5.9" (150mm)	
	Speed	Rapid travel speed (X, Y) (inch / min)	X=1968 (50m/min) Y=3937 (100m/min) High Speed Mode	
		Rapid Zaxis (inch)	2560 (65mm)	
Max. processing feedrate (inch / min)		1181 (30m/min)		
Precision	Positioning precision	(inch)0.0019/20 (0.05/ 500mm) (X, Y axis), 0.0039/4 (0.01/ 100mm) (Z axis)		
Drive motor type		Intelligent AC Servo		
Max. workpiece weight (lb)		8200 (3720kg)	8800(4000kg)	
Installation dimensions (W x D) (inch)		477 x 319.5 (12115 x 8115 mm)	708.7 x 354.3 (18000 x 9000mm)	
Machine system weight (lb)		20300 (9200kg)	35,700 (16200kg)	
Machine power requirements		CF-R 77 KVA 3Ø 208 VAC ±5% 60Hz 220 Full Load Amps	XF 98 KVA 3Ø 208 VAC ±5% 60Hz 280 Full Load Amps	

MC RP 2,500 3-15

CO₂ Laser Specifications

Model		45CF-R	60XF		
Excitation method		3-axis cross flow, silent discharge			
Performance	Laser power	Maximum output power (W)	4500		
		Rated output power (W)	4500		
		Control method	Power feedback		
		Power stability	Less than ±1% of rated power		
		Beam characteristics	Beam mode	Low-order (main component TEM ₀₁ *)	
			Beam outer diameter (inch)	1.02 (26 mm)	
Beam divergence (mrad)	Approx. 3.5 or less (total angle)				
Laser gas composition	CO ₂ -CO-N ₂ -He	8:4:60:28			
Laser gas consumption rate (liter/Hr)	3				
Gas sealing time (during rated continuous oscillation) (Hr)	24 (during rated continuous oscillation)				
Wave length (µm)	10.6				
Frequency setting range (Hz)	10~3000				
Duty range (%)	0~100 adjustable				
Output power adjustable range (%)	0~100 of rating				
Resonator unit dimensions (W x H x D)	98.4 x 71.3 x 31.5 (2,500 x 1,800 x 800 mm)	102.4 x 77.2 x 31.5 (2,600 x 1,960 x 800 mm)			
Resonator unit weight (lb)	4850 (2,200 kg)	4960 (2,250 kg)			
Chiller power requirements	46 KVA 3Ø 208 VAC ±10% 60Hz 129 Full Load Amps	54 KVA 3Ø 208 VAC ±10% 60Hz 155 Full Load Amps			

DANGER

VISIBLE AND/OR INVISIBLE LASER RADIATION-AVOID EYE OR SKIN EXPOSURE TO DIRECT OR SCATTERED RADIATION

MAX-OUTPUT	CO ₂	LD
WAVELENGTH	10.6µm	0.670µm
CLASS	IV	II

LASER PRODUCT

This product complies with CFR 1040. 10.
Data provided in this brochure is for reference only.



MC MACHINERY SYSTEMS, INC.

1500 Michael Drive, Wood Dale, IL 60191 | Tel: 630-616-5920, Fax: 630-616-4068 | www.mcmachinery.com